

LOBED DRIVE NO. 45

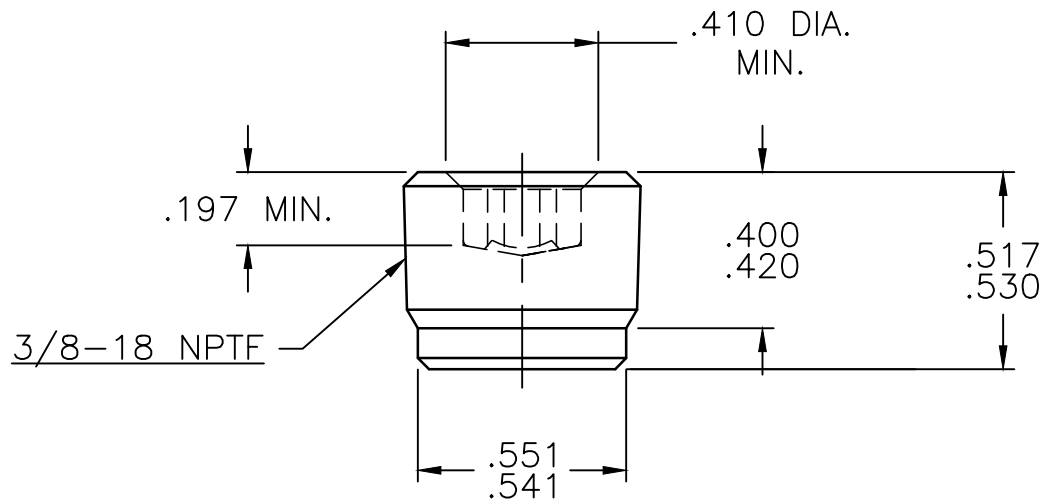

C/N	S	CHANGE	DATE	DR	CH	OK
	A					
	B					
	C					
	D					
	E					

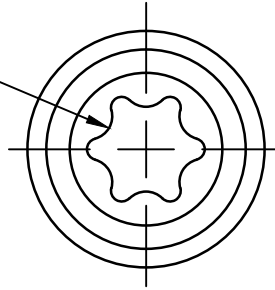
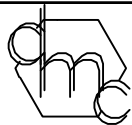

DECKER

MANUFACTURING CORPORATION

ALBION, MICHIGAN 49224
CONFIDENTIAL

THIS DOCUMENT IS THE EXCLUSIVE PROPERTY OF DECKER MANUFACTURING CORPORATION AND IS TO BE RETURNED TO THE COMPANY UPON REQUEST. THE CONTENTS ARE NOT TO BE USED IN ANY MANNER DETRIMENTAL TO THE INTERESTS OF THE COMPANY. THEY ARE NOT TO BE DISCLOSED OR REPRODUCED IN WHOLE OR IN PART WITHOUT EXPRESSED CONSENT.

PART NAME PIPE PLUG		
CUSTOMER PART NO.		
MATERIAL C1010 STEEL		
FINISH PLAIN		SCALE
DRAWN BY MAK	DATE 4/23/14	SHEET NO.
CHECKED BY	APPROVED BY	610-0833